



## **Van & Truck Cargo System**

Vantech USA www.vantech.com



### **PRODUCT INFO**

---

Part #: P3510S  
System: P3000  
Material: Aluminum  
Fitment: RAMBOX  
Color: Silver

### **REQUIRED TOOLS**

---

9/16" Wrench

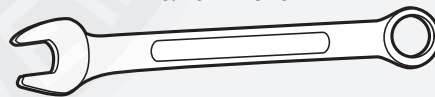

3/16" Allen Key Wrench

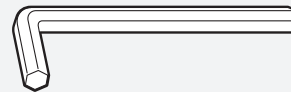









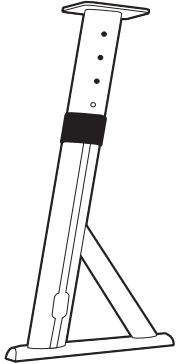

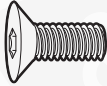
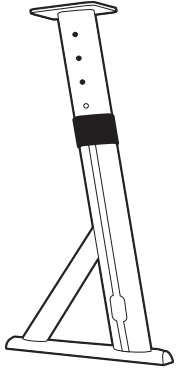
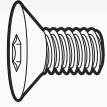
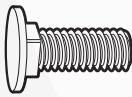
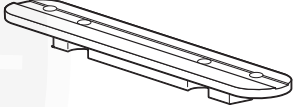
7/32" Allen Key Wrench



Marker

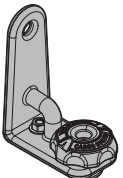

ITEM	INFO	QTY	ITEM	ITEM	INFO	QTY	ITEM
S101	3/8" SINGLE SLIDER (LENGTH 1")	4		P131	ADJUSTABLE UPRIGHT L	2	
S103	3/8" DOUBLE SLIDER (3" BOLT TO BOLT)	4					
B166	5/16" X 1" COUNTERSUNK BOLT	8		P132	ADJUSTABLE UPRIGHT R	2	
B177	3/8" X 3/4" COUNTERSUNK BOLT	8					
B502	3/8" X 1" CAR- RIAGE BOLT (SHAVED TOP)	8		A513	RAMBOX ADAPTOR	4	
N003	3/8" NUT	16		P013	ANGLED BRACE	4	
N017	3/8" KNOB SMALL	8		A286-55	3" X 1.5" X 55" CROSS BAR	2	
W013	3/8" X 3/4" WASHER	24		A286-C	PLASTIC ENDCAP	6	
W023	3/8" LOCK WASHER	16		A20	ADJUSTABLE LADDER GUIDE	4	

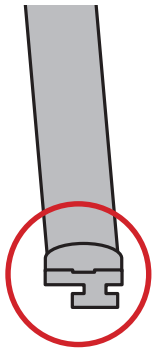

4X

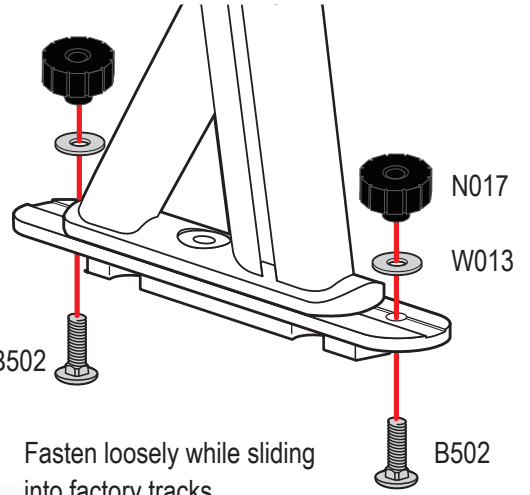
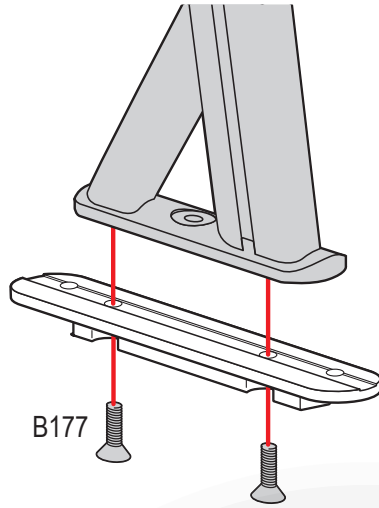

4X

Fasten loosely while sliding into factory tracks

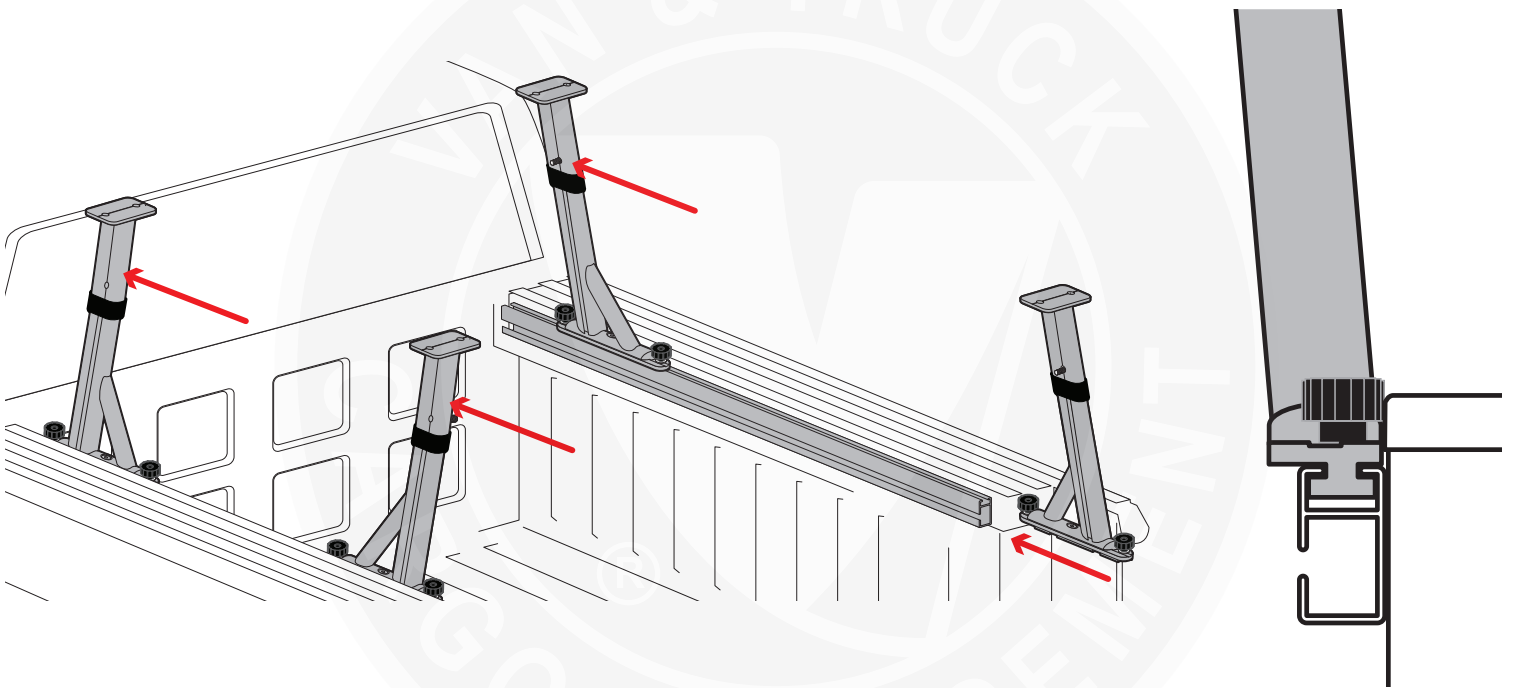

A286

S103

S101

2X

